

KOMATSU®

PC450LC-8

NET HORSEPOWER
257 kW **345 HP** @ 1900 rpm

OPERATING WEIGHT
44167 – 47200 kg
97,372 – 104,058 lb

BUCKET CAPACITY
1.12 – 2.87 m³ **1.47 – 3.75 yd³**

PC
450
LC



Photo may include optional equipment

HYDRAULIC EXCAVATOR

WALK-AROUND

Productivity Features

- **High Production and Low Fuel Consumption**
Powerful working performance and fuel efficiency increase production and lower fuel costs.
- **Excellent Machine Stability**
Large counterweight offers excellent machine stability and balance.
- **Higher Lifting Capacity**
Lifting mode is provided for increased lifting operation.
- **Large Digging Force**
Pressing the Power Max function button temporarily increases the digging force by 7%.
- **Automatic Three-Speed Travel**
- **Two-Mode Setting for Boom**
Switch selection allows either powerful digging or smooth boom operation.
- **Multi-Function Color Monitor**
 - Working mode selection
 - Self-diagnostic with EMMS
 - Attachment hydraulic oil flow adjustment

General Features

- Operator Protective Guard (OPG) top guard Level 2 capable
- New cab design for hydraulic excavators
- Engine neutral start with lock lever
- Slip-resistant plates for improved foot grip
- Pattern change valve is standard

Easy Maintenance

- Long replacement interval of engine oil, engine oil filter, hydraulic oil, and hydraulic filter
- Equipped with 10 micron fuel pre-filter as standard equipment (with water separator)
- Side-by-side cooling configuration enables individual cooling modules to be serviced
- Equipped with EMMS monitoring system
- Easy access to engine oil filter and fuel drain valve
- Large fuel tank capacity
- KOMTRAX®



KOMTRAX equipped machines can send location, SMR and operation maps to a secure website utilizing wireless technology. Machines also relay error codes, cautions, maintenance items, fuel levels, and much more.

NET HORSEPOWER257 kW **345 HP** @ 1900 rpm**OPERATING WEIGHT**

44167 – 47200 kg

97,372 – 104,058 lb**BUCKET CAPACITY**1.12 – 2.87 m³**1.47 – 3.75 yd³*****Ecology and Economy Features***

- Low emission engine
- A powerful turbocharged and air-to-air aftercooled Komatsu SAA6D125E-5 engine provides 257 kW **345 HP** net. This engine is EPA Tier 3 and EU stage 3A emissions certified without sacrificing power or machine productivity.
- Economy mode reduces fuel consumption
- Low operation noise

Excellent Reliability and Durability

- High rigidity work equipment
- Heavy duty boom assembly
- Sturdy frame structure
- Reliable Komatsu manufactured major components
- Highly reliable electronic devices
- Large clearance between the revolving frame and track to reduce the possibility of revolving frame damage

Large Comfortable Cab

- Low-noise cab design
- Low vibration with cab damper mounting
- Highly pressurized cab with automatic air conditioner
- Operator seat and console with armrest enables adjustment to the proper operational position

Large TFT LCD Monitor

- Large, easy-to-use, 7" multi-color monitor
- Can be displayed in ten languages for global support

TFT: Thin Film Transistor
LCD: Liquid Crystal Display



Photo may include optional equipment

Variable Track Gauge (optional)

- Greatly increases lateral stability
- Compliant with transportation regulations

PRODUCTIVITY FEATURES



Komatsu's new "ecot3" engines are designed to deliver optimum performance under the toughest of conditions while meeting the latest environmental regulations. This engine is EPA Tier 3 and EU Stage 3A emissions certified. "ecot3" – ecology and economy combined with Komatsu technology to create a high performance engine without sacrificing power or productivity.

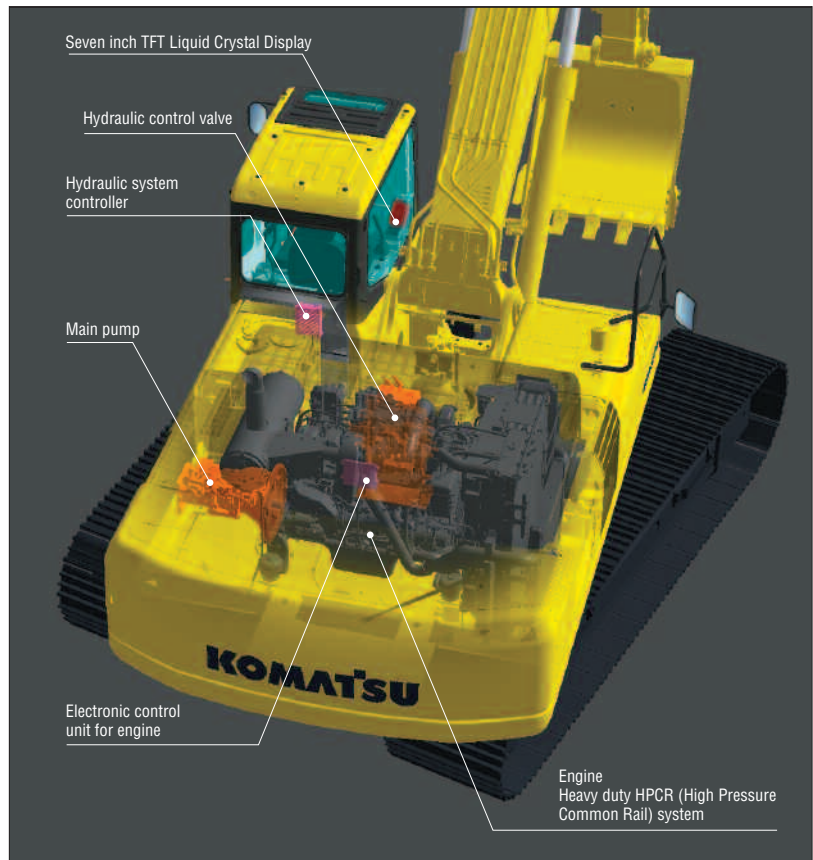

Environment-Friendly Clean Engine

The PC450LC-8 gets its exceptional power and work capacity from a Komatsu SAA6D125E-5 engine. Net output is 257 kW **345 HP**, providing increased hydraulic power and improved fuel efficiency.

The Komatsu SAA6D125E-5 engine is EPA Tier 3 and EU stage 3A emission certified with NOx emission reduced by 38%.

The SAA6D125E-5 engine adopts the electronically controlled Heavy Duty HPCR* fuel injection system and the world's first cooled EGR system with electronically controlled bypass-assist type venturi.



*HPCR: High Pressure Common Rail

Large Digging Force

With the one-touch Power Max function digging force is increased (8.5 seconds of operation).

Maximum arm crowd force (ISO):

200 kN (20.4t) ➔ **214 kN (21.8t)** (with Power Max) **7% UP**

Maximum bucket digging force (ISO):

256 kN (26.1t) ➔ **275 kN (28.0t)** (with Power Max) **7% UP**

*Measured with Power Max function, 3380 mm 11'1" arm and ISO rating

Smooth Loading Operation

Two return hoses improve hydraulic performance. In the arm out function, a portion of the oil is returned directly to the tank providing smooth operation.

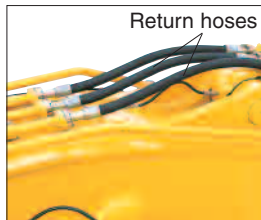

Two Mode Settings for Boom

Smooth mode provides easy operation for gathering blasted rock or scraping down operation. When maximum digging force is needed, switch to Power mode for more effective excavating.

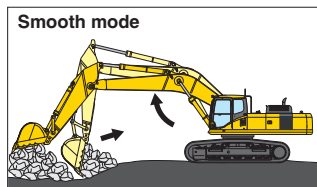

Boom floats upward, reducing lifting of machine front. This facilitates gathering blasted rock and scraping down operations.

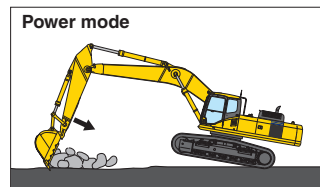

Boom pushing force is increased, ditch digging and box digging operation on hard ground are improved.

Variable Track Gauge (optional)

- Lateral stability is significantly improved when operating with the gauge extended.
- Lateral stability is greatly and effectively increased (compared with the fixed gauge version).
- With track frames retracted, overall width complies with many local transportation regulations.

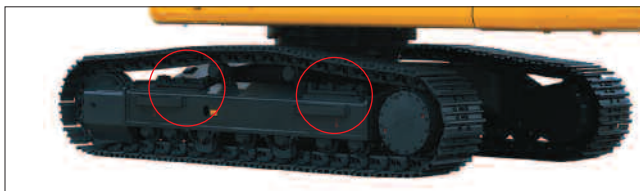

Working Mode Selection

The PC450LC-8 excavator is equipped with five working modes (P, E, L, B, and ATT modes). Each mode is designed to match engine speed, pump flow, and system pressure with the current application. This provides the flexibility to match equipment performance to the job at hand.

Working Mode	Application	Advantage
P	Power mode	<ul style="list-style-type: none"> • Maximum production/power • Fast cycle times
E	Economy mode	<ul style="list-style-type: none"> • Excellent fuel economy
L	Lifting mode	<ul style="list-style-type: none"> • Hydraulic pressure is increased by 7%
B	Breaker mode	<ul style="list-style-type: none"> • Optimum engine rpm, hydraulic flow, 1-way
ATT	Attachment mode	<ul style="list-style-type: none"> • Optimum engine rpm, hydraulic flow, 2-way

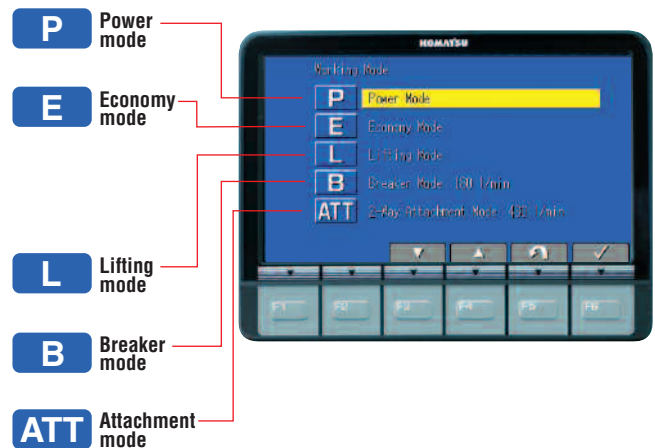

Economy Mode

Economy mode is environmentally friendly. Fuel consumption is reduced 11% (compared with PC450LC-8 Power mode).

Lifting Mode

When the lifting mode is selected, lifting capacity is increased 7% by raising hydraulic pressure.

Breaker Mode

Flow can be adjusted from the cab to match various one-way flow attachment requirements.

Attachment Mode

Flow can be adjusted from the cab to match various two-way flow attachment requirements.

Automatic Three-Speed Travel

Travel speed is automatically shifted between high/mid/low speeds according to the pressure required to travel.

WORKING ENVIRONMENT



Low Noise Cab

The newly-designed cab is highly rigid and has excellent sound absorption ability. Through improvement of noise source reduction and use of a low noise engine, hydraulic equipment, and air conditioner, this machine generates a low level of noise similar to that of a modern automobile.

Low Vibration with Cab Damper Mounting

PC450LC-8 uses a multi-layer viscous mount system that incorporates a longer stroke and the addition of a spring. The new cab damper mounting combined with a high rigidity deck aids vibration reduction at the operator seat.

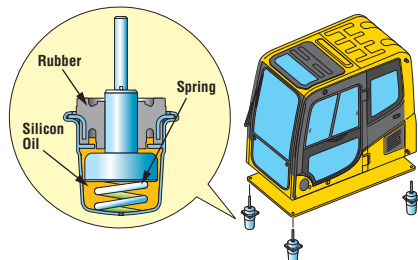

Wide Newly-Designed Cab

Newly-designed wide spacious cab includes high-back seat with reclining backrest. The seat height and longitudinal inclination are easily adjusted using a pull-up lever. You can set the appropriate operational posture of the armrest together with the console. Reclining the seat further enables you to place it into the fully flat state with the headrest attached.



Pressurized Cab

Automatic air conditioner, air filter, and a higher internal air pressure (+6.0 mm Aq +0.2" Aq) help minimize external dust from entering the cab.

Automatic Air Conditioner

Enables you to easily and precisely set cab atmosphere with the simple touch pad controls on the large LCD. The bi-level control function improves air flow and keeps the operator comfortable throughout the year. Defroster function keeps the cab glass clear.



GENERAL FEATURES

New Cab Design for Hydraulic Excavators

The cab is designed specifically for hydraulic excavators and gains reinforced strength from the pipe-structured cab framework. The cab framework provides high durability and impact resistance with very high impact absorbency.

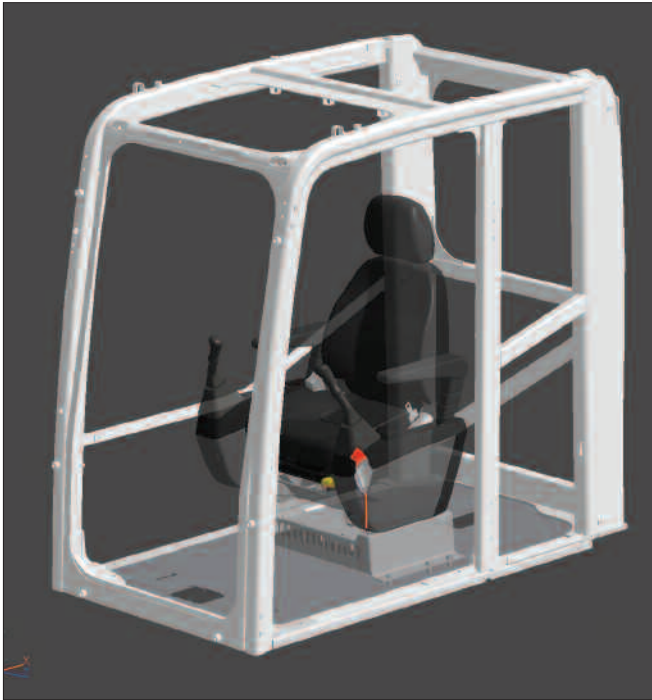

Slip-Resistant Plates

Highly durable slip-resistant plates maintain excellent foot traction performance for the long term.



Lock Lever

Makes all hydraulic cab controls inoperable when placed in lock position. Neutral start function allows the machine to be started only in the lock position.



Lock Lever in Lock Position

Thermal and Fan Guards

Guarding is placed around high-temperature parts of the engine and fan drive.

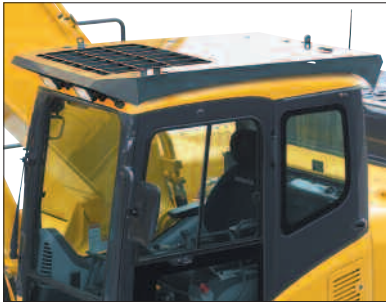

*Operator Protective Guard (OPG) Level 2
Top Guard (optional)*

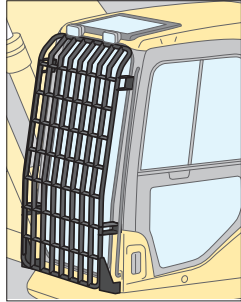

*Front Full Guard Level 2
(optional)*



Large Serrated Steps



Hand Rail

Skylight

Skylight can be opened to improve overhead visibility.



MAINTENANCE FEATURES

Self-Diagnostic Monitor

The PC450LC-8 features the most advanced diagnostics system in the industry. The Komatsu-exclusive system identifies maintenance items, reduces diagnostic times, indicates oil and filter replacement hours, and displays error codes.

Continuous Machine Monitoring System

When the starting switch is turned ON, check-before-starting items and caution items appear on the LCD. If abnormalities are found, a warning lamp blinks and a warning buzzer sounds. The continuous machine condition checks help prevent the development of serious problems and allow the operator to concentrate on the work at hand.

Abnormalities Display with Code

When an abnormality occurs during operation, a user code is displayed. When an important user code is displayed, a caution lamp blinks and a warning buzzer sounds to alert the operator to take action.

Oil Maintenance Function

When the machine exceeds the oil or filter replacement time, the oil maintenance monitor will display lights to inform the operator.

Trouble Data Memory Function

The monitor stores a record of abnormalities for effective troubleshooting.

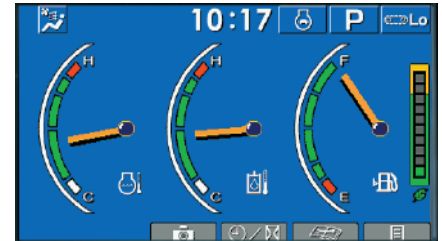

Normal display

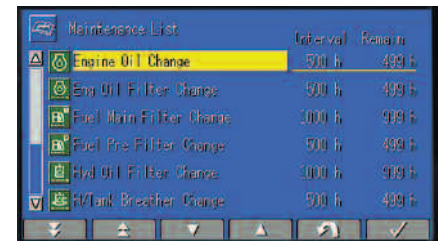

Maintenance time display

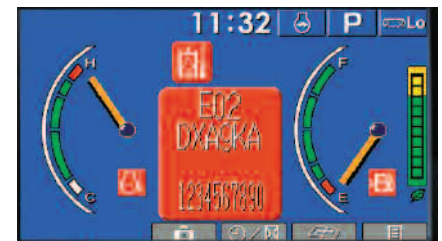

Error code display

Easy Maintenance

Komatsu designed the PC450LC-8 to have easy service access. We know by doing this, routine maintenance and servicing are more likely to be performed, which can mean a reduction in costly downtime later on. Here are some of the many service features found on the PC450LC-8.

Easy Radiator Cleaning

Since the radiator and oil cooler are arranged in side-by-side modules, it is easy to clean, remove, and install them.

Easy Access to Engine Oil Filter and Fuel Drain Valve

Engine oil dipstick and fill, oil filter, and fuel filters are mounted on the same side to improve accessibility.

Fuel drain valve is remotely mounted to improve accessibility.

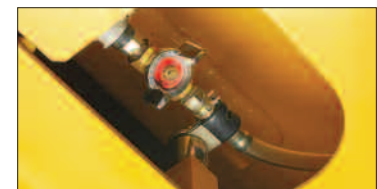

Fuel Drain Valve



Equipped with Fuel Pre-Filter (with water separator)

Removes water and contaminants in the fuel to help prevent fuel problems.



Equipped with Eco-Drain Valve as Standard

Enables easier and cleaner engine oil changes.

Maintenance Cost Reduction

Long Replacement Interval of Hydraulic and Engine Oil and Filters

High performance filters are used in the hydraulic circuit and engine. By increasing the hydraulic oil, hydraulic oil filter, engine oil, and engine oil filter replacement intervals, maintenance costs are significantly reduced.

Engine oil	
Engine oil filter	every 500 hours
Hydraulic oil	every 5000 hours
Hydraulic oil filter	every 1000 hours



Long Work Equipment Greasing Interval

High quality BMRC bushings and resin shims are installed in the work equipment, excluding the bucket, which can extend the greasing interval to 500 hours.

Large Capacity Air Cleaner

Large capacity air cleaner is comparable to those installed in larger machines. The large air cleaner extends filter element life and service intervals.



Large Fuel Tank Capacity

Large fuel tank capacity extends operating hours before refueling. Fuel tank is treated for rust prevention and improved corrosion resistance.

High Pressure In-Line Filters

High pressure in-line filters are installed at the pump discharge ports. This provides an additional level of hydraulic system protection.

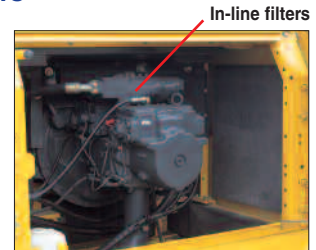

RELIABILITY FEATURES

High Rigidity Work Equipment

Boom and arms are constructed with thick plates of high tensile strength steel. In addition, these structures are designed with large cross-sectional areas and generous use of castings. The result is working attachments that exhibit long term durability and high resistance to bending and torsional stress. An HD boom assembly is offered for increased strength and reliability.

Sturdy Frame Structure

The revolving frame, center frame, and undercarriage are designed by using the most advanced three-dimensional CAD and FEM analysis technology.

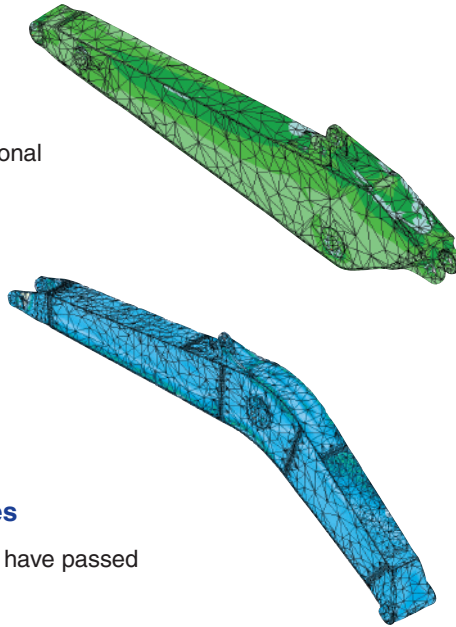

Reliable Components

All of the major machine components such as engine, hydraulic pumps, hydraulic motors, and control valves are exclusively designed and manufactured by Komatsu.

Highly Reliable Electronic Devices

Exclusively designed electronic devices have passed severe testing.

- Controllers
- Sensors
- Connectors
- Wiring

Metal Guard Rings Protect All the Hydraulic Cylinders and Improve Reliability

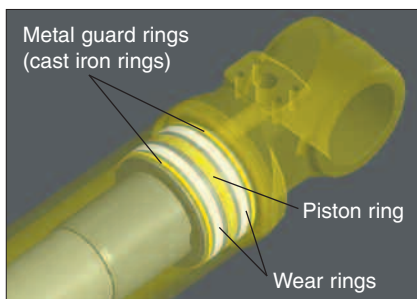

DT-Type Electrical Connectors

DT-type connectors seal tightly and have higher reliability.

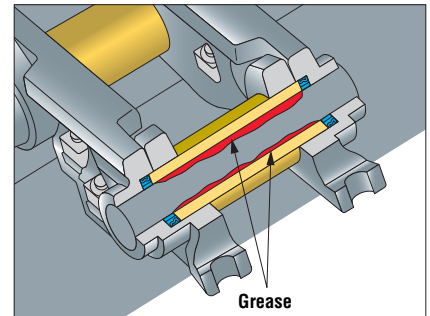
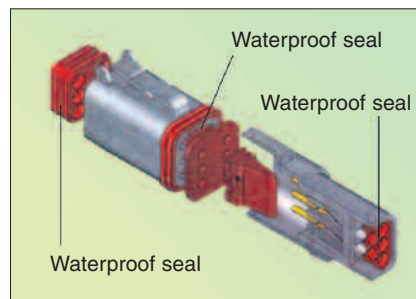

Grease Sealed Track

PC450LC-8 uses grease sealed tracks for extended undercarriage life.

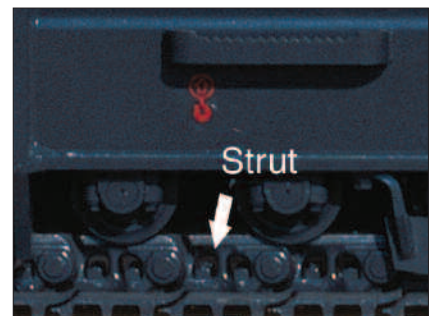

Track Link with Strut

PC450LC-8 uses track links with strut, providing superb durability

O-Ring Face Seals

Hydraulic hoses are equipped with O-ring seals versus conventional taper seals to provide extended leak-free life.

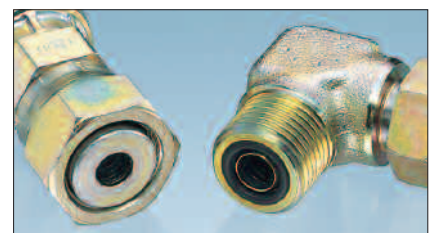

Reduced Revolving Frame Damage

Damage to the revolving frame is reduced by the substantial clearance between the revolving frame and track.

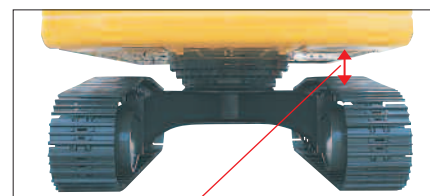

Clearance: approx. 200mm **7.9"**

Large LCD Color Monitor

Large Multi-Lingual LCD Monitor

A large user-friendly color monitor enables accurate and smooth work. Improved screen visibility is achieved by use of a TFT liquid crystal display that can easily be read at various angles and lighting conditions. All switches are simple and easy to operate. Industry-first function keys facilitate multi-function operations. Displays data in 10 languages to globally support operators around the world.

Indicators

- 1 Auto-decelerator
- 2 Working mode
- 3 Travel speed
- 4 Engine water temperature gauge
- 5 Hydraulic oil temperature gauge
- 6 Fuel gauge
- 7 Eco-gauge
- 8 Function switches menu

Basic operation switches

- 1 Auto-decelerator
- 2 Working mode selector
- 3 Travel speed selector
- 4 Buzzer cancel
- 5 Wiper
- 6 Windshield washer



Rear-view Camera Display

On the large LCD color monitor, the operator can access and view one standard video camera that will display areas directly behind the machine. An optional 2 camera system is available.



Equipment Management Monitoring System (EMMS)

Monitor Function

Controller monitors engine oil level, coolant temperature, battery charge, air filter clogging, etc. If the controller finds any abnormality, it is displayed on the LCD.



SPECIFICATIONS



ENGINE

Model Komatsu SAA6D125E-5
 Type Water-cooled, 4-cycle, direct injection
 Aspiration Turbocharged, aftercooled, cooled EGR
 Number of cylinders 6
 Bore 125 mm **4.92"**
 Stroke 150 mm **5.91"**
 Piston displacement 11.04 ltr **674 in³**
 Horsepower:
 SAE J1995 Gross 270 kW **362 HP**
 ISO 9249 / SAE J1349 Net 257 kW **345 HP**
 Rated rpm 1900 rpm
 Fan drive type Mechanical
 Governor All-speed control, electronic

EPA Tier 3 and EU stage 3A emission certified.



HYDRAULIC SYSTEM

Type HydrauMind (Hydraulic Mechanical Intelligence New Design) system, closed-center with load sensing and pressure compensated valves
 Number of selectable working modes 5
 Main pump:
 Type Variable displacement piston type
 Pumps for Boom, arm, bucket, swing, and travel circuits
 Maximum flow 690 ltr/min **182 U.S. gal/min**
 Supply for control circuit Self-reducing valve
 Hydraulic motors:
 Travel 2 x axial piston motors with parking brake
 Swing 1 x axial piston motor with swing holding brake
 Relief valve setting:
 Implement circuits 37.3 MPa 380 kgf/cm² **5,400 psi**
 Travel circuit 37.3 MPa 380 kgf/cm² **5,400 psi**
 Swing circuit 27.9 MPa 285 kgf/cm² **4,050 psi**
 Pilot circuit 3.2 MPa 33 kgf/cm² **470 psi**
 Hydraulic cylinders:
 (Number of cylinders – bore x stroke x rod diameter)
 Boom 2–160 mm x 1570 mm x 110 mm **6.3" x 61.8" x 4.3"**
 Arm except 2.4 m **7'10" arm**
 1–185 mm x 1820 mm x 120 mm **7.3" x 71.7" x 4.7"**
 for 2.4 m **7'10" arm**
 1–185 mm x 1590 mm x 120 mm **7.3" x 62.6" x 4.7"**
 Bucket 1–160 mm x 1270 mm x 110 mm **6.3" x 50" x 4.3"**



DRIVES AND BRAKES

Steering control Two levers with pedals
 Drive method Hydrostatic
 Maximum drawbar pull 329 kN 33510 kgf **73,880 lb**
 Gradeability 70%, 35°
 Maximum travel speed: High 5.5 km/h **3.4 mph**
 (Auto-Shift) Mid 4.4 km/h **2.7 mph**
 (Auto-Shift) Low 3.0 km/h **1.9 mph**
 Service brake Hydraulic lock
 Parking brake Mechanical disc brake



SWING SYSTEM

Drive method Hydrostatic
 Swing reduction Planetary gear
 Swing circle lubrication Grease-bathed
 Service brake Hydraulic lock
 Holding brake/Swing lock Mechanical disc brake
 Swing speed 9.0 rpm
 Swing torque 13414 Kg·m **97,024 ft. lbs.**



UNDERCARRIAGE

Center frame X-frame
 Track frame Box-section
 Track type Sealed
 Track adjuster Hydraulic
 Number of shoes 49 each side
 Number of carrier rollers 2 each side
 Number of track rollers 8 each side



COOLANT AND LUBRICANT CAPACITY (REFILLING)

Fuel tank 650 ltr **172 U.S. gal**
 Coolant 36.8 ltr **9.7 U.S. gal**
 Engine 38.0 ltr **10.0 U.S. gal**
 Final drive, each side 12.0 ltr **3.2 U.S. gal**
 Swing drive 16.2 ltr **4.3 U.S. gal**
 Hydraulic tank 248 ltr **65.5 U.S. gal**



OPERATING WEIGHT (APPROXIMATE)

Operating weight including 7060 mm **23'2"** one-piece boom, 3380 mm **11'1"** arm, SAE heaped 1.94 m³ **2.54 yd³** bucket, rated capacity of lubricants, coolant, full fuel tank, operator, and standard equipment.

Shoes	PC450LC-8		PC450LC-8 Variable Gauge	
	Operating Weight	Ground Pressure	Operating Weight	Ground Pressure
700 mm 28"	44810 kg 98,788 lb	0.68 kgf/cm ² 9.74 psi	45865 kg 101,158 lb	0.70 kgf/cm ² 9.97 psi
800 mm 31.5"	45290 kg 99846 lb	0.60 kgf/cm ² 8.61 psi	46365 kg 102,216 lb	0.62 kgf/cm ² 8.82 psi
900 mm 35.5"	45738 kg 100,860 lb	0.54 kgf/cm ² 7.74 psi	46825 kg 103,230 lb	0.56 kgf/cm ² 7.92 psi



WORKING FORCES

	Arms	2400 mm 7'10"	2900 mm 9'6"	3380 mm 11'1"	4000 mm 13'1"	4800 mm 15'9"
SAE rating	Bucket digging force at Power Max	24600 kgf 54,230 lb	24500 kgf 54,010 lb	24400 kgf 53,790 lb	24400 kgf 53,790 lb	24400 kgf 53,790 lb
	Arm crowd force at Power Max	24600 kgf 54,230 lb	25000 kgf 55,120 lb	20900 kgf 46,080 lb	18800 kgf 41,450 lb	16500 kgf 36,400 lb
ISO rating	Bucket digging force at Power Max	28200 kgf 62,170 lb	28100 kgf 61,950 lb	28000 kgf 61,730 lb	27500 kgf 60,630 lb	27500 kgf 60,630 lb
	Arm crowd force at Power Max	25900 kgf 57,100 lb	26200 kgf 57,760 lb	21800 kgf 48,060 lb	19400 kgf 42,770 lb	17000 kgf 37,500 lb



DIMENSIONS

	Arm	2400 mm	7'10"	2900 mm	9'6"	3380 mm	11'1"	4000 mm	13'1"	4800 mm	15'9"
A	Overall length	11905 mm	39'1"	11995 mm	39'4"	11940 mm	39'2"	11950 mm	39'2"	11795 mm	38'8"
B	Length on ground (transport)	8375 mm	27'6"	7475 mm	24'6"	6705 mm	22'0"	6330 mm	20'9"	6035 mm	20'
C	Overall height (to top of boom)	3850 mm	12'8"	3745 mm	12'3"	3635 mm	11'11"	3885 mm	12'9"	4435 mm	14'7"
D	Overall width	3640 mm	11'11"								
E	Overall height (to top of cab)	3265 mm	10'9"								
F	Ground clearance, counterweight	1320 mm	4'4"								
G	Ground clearance, (minimum)	550 mm	1'10"								
H	Tail swing radius	3645 mm	12'0"								
I	Track length on ground	4350 mm	14'3"								
J	Track length	5385 mm	17'8"								
K	Track gauge	2740 mm	9'0"								
L	Width of crawler	3640 mm	11'11"								
M	Shoe width	900 mm	35.5"								
N	Grouser height	37 mm	1.5"								
O	Machine cab height	2885 mm	9'6"								
P	Machine cab width	2995 mm	9'10"								
Q	Distance, swing center to rear end	3605 mm	11'10"								

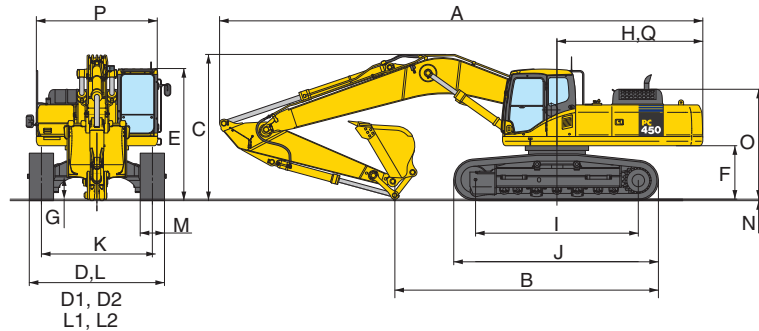

Variable Gauge Transportation Dimension Differences	
D1	Overall width (crawler retracted) 3290 mm 10'10"
D2	Overall width (crawler extended) 3790 mm 12'5"
G	Ground clearance (minimum) 685 mm 2'3"
K	Track gauge (crawler extended) 2890 mm 9'6"
L1	Width of crawler (retracted) 3290 mm 10'10"
L2	Width of crawler (extended) 3790 mm 12'5"
M	Track shoe width 900 mm 35.5"



BACKHOE BUCKET, ARM, AND BOOM COMBINATION

Bucket Type	Bucket			Arms				
	Capacity	Width	Weight	2400 mm 7'10"	2900 mm 9'6"	3380 mm 11'1"	4000 mm 13'1"	4800 mm 15'9"
Komatsu TL	1.12 m ³ 1.47 yd ³	762 mm 30"	1287 kg 2,838 lb	V	V	V	V	V
	1.35 m ³ 1.76 yd ³	914 mm 36"	1441 kg 3,176 lb	V	V	V	V	V
	1.64 m ³ 2.15 yd ³	1067 mm 42"	1561 kg 3,442 lb	V	V	V	V	V
	1.94 m ³ 2.54 yd ³	1219 mm 48"	1714 kg 3,779 lb	V	V	V	W	W
	2.25 m ³ 2.94 yd ³	1372 mm 54"	1867 kg 4,117 lb	W	W	W	X	X
	2.55 m ³ 3.34 yd ³	1524 mm 60"	1988 kg 4,382 lb	X	X	X	Y	Y
	2.87 m ³ 3.75 yd ³	1676 mm 66"	2141 kg 4,720 lb	X	Y	Y	Z	Z
Komatsu GSK	1.12 m ³ 1.47 yd ³	762 mm 30"	1266 kg 2,790 lb	V	V	V	V	V
	1.35 m ³ 1.76 yd ³	914 mm 36"	1393 kg 3,072 lb	V	V	V	V	V
	1.64 m ³ 2.15 yd ³	1067 mm 42"	1536 kg 3,386 lb	V	V	V	V	V
	1.94 m ³ 2.54 yd ³	1219 mm 48"	1646 kg 3,629 lb	V	V	V	W	W
	2.25 m ³ 2.94 yd ³	1372 mm 54"	1790 kg 3,947 lb	V	W	W	X	X
	2.55 m ³ 3.34 yd ³	1524 mm 60"	1903 kg 4,195 lb	W	X	X	Y	Y
	2.87 m ³ 3.75 yd ³	1676 mm 66"	2066 kg 4,553 lb	Y	Y	Y	Z	Z
Komatsu HP	1.12 m ³ 1.47 yd ³	762 mm 30"	1508 kg 3,324 lb	V	V	V	V	V
	1.35 m ³ 1.76 yd ³	914 mm 36"	1663 kg 3,667 lb	V	V	V	V	V
	1.64 m ³ 2.15 yd ³	1067 mm 42"	1835 kg 4,046 lb	V	V	V	V	V
	1.94 m ³ 2.54 yd ³	1219 mm 48"	1978 kg 4,360 lb	V	V	W	W	X
	2.25 m ³ 2.94 yd ³	1372 mm 54"	2151 kg 4,741 lb	W	W	X	X	Y
	2.55 m ³ 3.34 yd ³	1524 mm 60"	2293 kg 5,056 lb	X	X	Y	Y	Y
	2.87 m ³ 3.75 yd ³	1676 mm 66"	2466 kg 5,437 lb	Y	Y	Y	Z	Z
Komatsu HPS	1.12 m ³ 1.47 yd ³	762 mm 30"	1632 kg 3,597 lb	V	V	V	V	V
	1.35 m ³ 1.76 yd ³	914 mm 36"	1806 kg 3,981 lb	V	V	V	V	V
	1.64 m ³ 2.15 yd ³	1067 mm 42"	2003 kg 4,416 lb	V	V	V	V	W
	1.94 m ³ 2.54 yd ³	1219 mm 48"	2172 kg 4,789 lb	V	V	W	X	X
	2.25 m ³ 2.94 yd ³	1372 mm 54"	2371 kg 5,228 lb	W	X	X	Y	Y
	2.55 m ³ 3.34 yd ³	1524 mm 60"	2540 kg 5,600 lb	X	Y	Y	Z	Z
	2.87 m ³ 3.75 yd ³	1676 mm 66"	2739 kg 6,039 lb	Y	Y	Z	Z	Z
Komatsu HPX	1.12 m ³ 1.47 yd ³	762 mm 30"	1759 kg 3,877 lb	V	V	V	V	V
	1.35 m ³ 1.76 yd ³	914 mm 36"	1933 kg 4,261 lb	V	V	V	V	V
	1.64 m ³ 2.15 yd ³	1067 mm 42"	2130 kg 4,696 lb	V	V	V	W	W
	1.94 m ³ 2.54 yd ³	1219 mm 48"	2299 kg 5,069 lb	V	W	W	X	X
	2.25 m ³ 2.94 yd ³	1372 mm 54"	2498 kg 5,508 lb	X	X	X	Y	Y
	2.55 m ³ 3.34 yd ³	1524 mm 60"	2667 kg 5,880 lb	X	Y	Y	Z	Z
	2.87 m ³ 3.75 yd ³	1676 mm 66"	2866 kg 6,319 lb	Y	Y	Z	Z	Z

V – Used with densities up to 3,500 lb/yd³, W – Used with densities up to 3,000 lb/yd³
 X – Used with densities up to 2,500 lb/yd³, Y – Used with densities up to 2,000 lb/yd³, Z – Not useable

WORKING RANGES

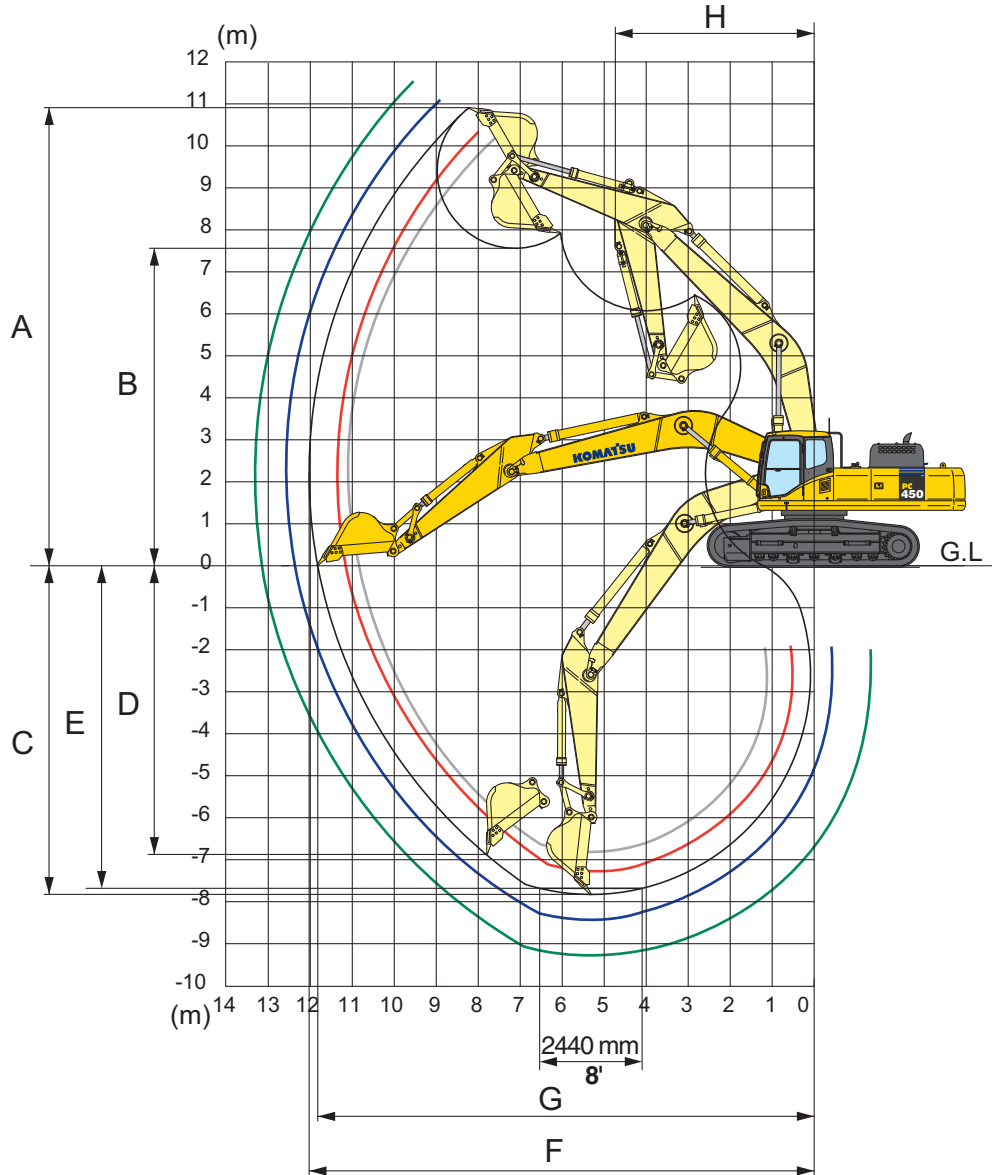

	Arm	2400 mm 7'10"	2900 mm 9'6"	3380 mm 11'1"	4000 mm 13'1"	4800 mm 15'9"
A	Max. digging height	10310 mm 33'10"	10285 mm 33'9"	10915 mm 35'10"	11025 mm 36'2"	11485 mm 37'8"
B	Max. dumping height	7070 mm 23'2"	7080 mm 23'3"	7565 mm 24'10"	7715 mm 25'4"	8145 mm 26'9"
C	Max. digging depth	6845 mm 22'6"	7345 mm 24'1"	7820 mm 25'8"	8445 mm 27'8"	9255 mm 30'4"
D	Max. vertical wall digging depth	5305 mm 17'5"	5700 mm 18'8"	6870 mm 22'6"	7285 mm 23'11"	8150 mm 26'9"
E	Max. digging depth of cut for 8' level	6650 mm 21'10"	7155 mm 23'6"	7680 mm 25'2"	8315 mm 27'3"	9145 mm 30'0"
F	Max. digging reach	11080 mm 36'4"	11445 mm 37'7"	12025 mm 39'5"	12565 mm 41'3"	13365 mm 43'10"
G	Max. digging reach at ground level	10855 mm 35'7"	11230 mm 36'10"	11820 mm 38'9"	12365 mm 40'7"	13180 mm 43'3"
H	Min. swing radius	4835 mm 15'10"	4810 mm 15'9"	4735 mm 15'6"	4800 mm 15'9"	4885 mm 16'0"

LIFTING CAPACITIES



STANDARD TRACK LIFTING CAPACITY

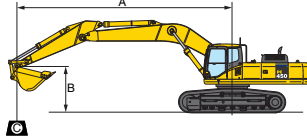

- A: Reach from swing center
- B: Bucket hook height
- C: Lifting capacity
- Cf: Rating over front
- Cs: Rating over side
- ⊗: Rating at maximum reach

- Conditions:
- Boom length: 7060 mm 23'2"
 - Bucket: 1.90 m³ 2.49 yd³
 - Bucket weight: 1325 kg 2,920 lb.
 - Lifting mode: On

PC450LC-8		Arm 2400 mm 7'10"		Shoe 900 mm 35.5"		Unit: kg/lb							
B	A MAX	3.0 m 10'		4.6 m 15'		6.1 m 20'		7.6 m 25'		9.1 m 30'		⊗ MAX	
		Cf	Cs	Cf	Cs	Cf	Cs	Cf	Cs	Cf	Cs	Cf	Cs
7.6 m 25'	8.0 m 26'							*11000 *24,300	8800 19,500			*8050 *17,700	7950 17,600
6.1 m 20'	8.9 m 29'							*11250 *24,800	8700 19,200			*7850 *17,300	6550 14,500
4.6 m 15'	9.4 m 31'			*19750 *43,500	18750 41,400	*14800 *32,700	11950 26,400	*12100 *26,700	8350 18,500	10200 22,500	6150 13,500	*7900 *17,500	5800 12,800
3.0 m 10'	9.7 m 32'					*16800 37,000	11300 24,900	*13050 *28,800	8000 17,700	10000 22,100	5950 13,200	*8250 *18,200	5400 12,000
1.5 m 5'	9.7 m 32'					*17850 *39,300	10750 23,700	13100 28,900	7700 17,000	9850 21,700	5800 12,800	*8900 *19,700	5300 11,700
0 m 0'	9.4 m 31'					*17850 *39,400	10450 23,100	12900 28,400	7500 16,600	9700 21,400	5700 12,600	9300 20,500	5450 12,000
-1.5 m -5'	8.9 m 29'			*19800 *43,700	16450 36,300	*17100 *37,700	10400 23,000	12800 28,300	7450 16,400	9750 21,500	5700 12,600	10100 22,200	5900 13,100
-3.0 m -10'	8.1 m 27'	*19250 *42,500	*19250 *42,500	*18900 *41,600	16800 37,100	*15250 *33,700	10550 23,300	*11700 *25,800	7550 16,700			*10150 *22,400	6900 15,300
-4.6 m -15'	6.9 m 23'			*14750 *32,600	*14750 *32,600	*11750 *25,900	10800 23,800					*9100 *20,100	*9100 *20,100

PC450LC-8		Arm 2900 mm 9'6"		Shoe 900 mm 35.5"		Unit: kg/lb							
B	A MAX	3.0 m 10'		4.6 m 15'		6.1 m 20'		7.6 m 25'		9.1 m 30'		⊗ MAX	
		Cf	Cs	Cf	Cs	Cf	Cs	Cf	Cs	Cf	Cs	Cf	Cs
7.6 m 25'	8.0 m 26'							*10100 *22,300	8900 19,600			*10100 *22,300	7950 17,600
6.1 m 20'	8.9 m 29'							*10550 *23,200	8750 19,200			*9950 *22,000	6500 14,400
4.6 m 15'	9.4 m 31'			*18100 *39,900	*18100 *39,900	*13850 *30,600	12000 26,500	*11450 *25,200	8350 18,500	*10050 *22,200	6100 13,500	9600 21,100	5700 12,600
3.0 m 10'	9.7 m 32'					*15950 35,200	11300 24,900	*12500 *27,600	7950 17,600	9950 21,900	5900 13,000	9000 19,800	5300 11,700
1.5 m 5'	9.7 m 32'					*17350 *38,200	10650 23,500	13050 28,700	7600 16,800	9750 21,500	5700 12,600	8800 19,400	5150 11,300
0 m 0'	9.5 m 31'					*17650 *38,900	10300 22,700	12750 28,100	7350 16,300	9600 21,100	5550 12,200	9050 19,900	5250 11,600
-1.5 m -5'	9.0 m 29'			*22400 *49,400	16150 35,600	*17200 *37,900	10150 22,400	12650 27,800	7250 16,000	9550 21,000	5500 12,200	9750 21,500	5650 12,500
-3.0 m -10'	8.2 m 27'	*22750 *50,100	*22750 *50,100	*20100 *44,300	16350 36,100	*15750 *34,800	10250 22,600	*12250 *27,000	7300 16,100			*10850 *23,900	6550 14,500
-4.6 m -15'	6.9 m 23'	*19400 *42,700	*19400 *42,700	*16400 *36,100	*16400 *36,100	*12950 *28,600	10550 23,300					*10550 *23,300	8600 18,900

*Load is limited by hydraulic capacity rather than tipping. Ratings are based on SAE standard No. J1097. Rated loads do not exceed 87% of hydraulic lift capacity or 75% of tipping load.

PC450LC-8 HYDRAULIC EXCAVATOR

LIFTING CAPACITIES



STANDARD TRACK LIFTING CAPACITY *continued*

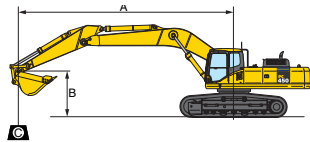

- A: Reach from swing center
- B: Bucket hook height
- C: Lifting capacity
- Cf: Rating over front
- Cs: Rating over side
- ☉: Rating at maximum reach

- Conditions:
- Boom length: 7060 mm **23'2"**
 - Bucket: 1.90 m³ **2.49 yd³**
 - Bucket weight: 1325 kg **2,920 lb.**
 - Lifting mode: On

PC450LC-8		Arm 3380 mm 11'1"		Shoe 900 mm 35.5"		Unit: kg/lb									
B	A MAX	3.0 m 10'		4.6 m 15'		6.1 m 20'		7.6 m 25'		9.1 m 30'		☉ MAX			
		Cf	Cs	Cf	Cs	Cf	Cs	Cf	Cs	Cf	Cs	Cf	Cs		
7.6 m 25'	8.8 m 29'											*6800 *15,000	*6800 *15,000		
6.1 m 20'	9.6 m 31'							*10050 *22,100	8900 19,700	*9350 *20,600	6400 14,100	*6800 *15,000	5800 12,800		
4.6 m 15'	10.1 m 33'					*13200 *29,100	12300 27,100	*11000 *24,300	8550 18,900	*9750 *21,500	6250 13,800	*7000 *15,400	5150 11,400		
3.0 m 10'	10.3 m 34'			*21050 *46,400	18050 39,700	*15400 *34,000	11600 25,500	*12200 *26,900	8150 17,900	10100 22,200	6000 13,300	*7400 *16,300	4800 10,600		
1.5 m 5'	10.3 m 34'			*18800 *41,400	16750 36,900	*17100 *37,700	10900 24,100	13150 29,000	7750 17,100	9850 21,700	5800 12,800	8050 17,700	4700 10,300		
0 m 0'	10.1 m 33'			*18100 *40,000	16250 35,800	*17750 *39,100	10500 23,100	12900 28,400	7500 16,500	9650 21,300	5650 12,400	8200 18,100	4750 10,500		
-1.5 m -5'	9.7 m 32'	*10650 *23,400	*10650 *23,400	*23450 *51,700	16200 35,700	*17550 *38,700	10300 22,700	12700 28,000	7350 16,200	9550 21,100	5550 12,200	8800 19,400	5100 11,200		
-3.0 m -10'	8.9 m 29'	*19150 *42,200	*19150 *42,200	*21400 *47,200	16350 36,100	*16450 *36,300	10300 22,700	12700 28,000	7350 16,200	9600 21,200	5600 12,300	9950 22,000	5800 12,800		
-4.6 m -15'	7.8 m 26'	*22850 *50,400	*22850 *50,400	*18150 *40,000	16550 36,400	*14150 *31,200	10500 23,200	*10600 *23,400	7500 16,500			*9800 *21,700	7200 15,900		
-6.1 m -20'	6.1 m 20'			*12800 *28,200	*12800 *28,200	*9500 *21,000	*9500 *21,000					*8700 *19,200	*8700 *19,200		

PC450LC-8		Arm 4000 mm 13'1"		Shoe 900 mm 35.5"		Unit: kg/lb									
B	A MAX	3.0 m 10'		4.6 m 15'		6.1 m 20'		7.6 m 25'		9.1 m 30'		☉ MAX			
		Cf	Cs	Cf	Cs	Cf	Cs	Cf	Cs	Cf	Cs	Cf	Cs		
7.6 m 25'	9.4 m 31'									*7800 *17,100	6600 14,600	*5850 *12,900	*5850 *12,900		
6.1 m 20'	10.2 m 33'									*8700 *19,100	6550 14,400	*5800 *12,800	5250 11,600		
4.6 m 15'	10.6 m 35'							*10300 *22,700	8700 19,200	*9200 *20,300	6350 14,000	*5950 *13,200	4700 10,400		
3.0 m 10'	10.9 m 36'			*20200 *44,600	18550 40,900	*14400 *31,700	11800 26,000	*11550 *25,500	8250 18,200	*9900 *21,800	6100 13,400	*6300 *13,900	4400 9,700		
1.5 m 5'	10.9 m 36'			*22700 *50,100	17000 37,500	*16400 *36,100	11050 24,300	*12700 *28,000	7800 17,200	9850 21,800	5800 12,800	*6850 *15,100	4250 9,400		
0 m 0'	10.7 m 35'			*21600 *47,600	16200 35,700	*17450 *38,500	10500 23,100	12900 28,400	7500 16,500	9650 21,300	5600 12,400	7500 16,600	4300 9,500		
-1.5 m -5'	10.2 m 34'	*11350 *25,100	*11350 *25,100	*23950 *52,800	15900 35,100	*17550 *38,700	10200 22,400	12650 27,900	7250 16,000	9500 21,000	5500 12,100	7950 17,600	4550 10,100		
-3.0 m -10'	9.5 m 31'	*19600 *43,200	*19600 *43,200	*22450 *49,500	16000 35,300	*16900 *37,200	10100 22,300	12550 27,700	7200 15,900	9500 20,900	5450 12,100	8900 19,600	5100 11,300		
-4.6 m -15'	8.5 m 28'	*25450 *56,100	*25450 *56,100	*19700 *43,500	16300 36,000	*15150 *33,400	10250 22,600	*11650 *25,700	7300 16,100			*9500 *20,900	6200 13,600		
-6.1 m -20'	7.0 m 23'	*19600 *43,200	*19600 *43,200	*15300 *33,700	*15300 *33,700	*11700 *25,800	10600 23,400					*9000 *19,900	8550 18,800		

*Load is limited by hydraulic capacity rather than tipping. Ratings are based on SAE standard No. J1097. Rated loads do not exceed 87% of hydraulic lift capacity or 75% of tipping load.



STANDARD TRACK LIFTING CAPACITY *continued*

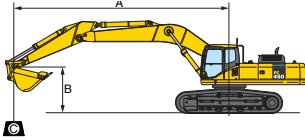

- A: Reach from swing center
- B: Bucket hook height
- C: Lifting capacity
- Cf: Rating over front
- Cs: Rating over side
- ⊗: Rating at maximum reach

- Conditions:
- Boom length: 7060 mm **23'2"**
 - Bucket: 1.90 m³ **2.49 yd³**
 - Bucket weight: 1325 kg **2,920 lb.**
 - Lifting mode: On

PC450LC-8		Arm 4800 mm 15'9"		Shoe 900 mm 35.5"										Unit: kg/lb	
A B	MAX	3.0 m 10'		4.6 m 15'		6.1 m 20'		7.6 m 25'		9.1 m 30'		⊗ MAX			
		Cf	Cs	Cf	Cs	Cf	Cs	Cf	Cs	Cf	Cs	Cf	Cs		
7.6 m 25'	10.4 m 34'											*4400 *9,750	*4400 *9,750		
6.1 m 20'	11.1 m 36'									*7650 *16,900	6550 14,500	*4380 *9,650	4380 9,650		
4.6 m 15'	11.5 m 38'									*8250 *18,250	6350 14,000	*4450 *9,850	3950 8,700		
3.0 m 10'	11.7 m 38'					*12800 *28,250	12000 26,500	*10450 *23,100	8300 18,300	*9050 *19,950	6050 13,350	*4650 *10,300	3700 8,150		
1.5 m 5'	11.7 m 38'			*21650 *47,750	17500 38,600	*15100 *33,350	11150 24,600	*11800 *26,050	7800 17,200	9800 21,650	5750 12,650	*5000 *11,050	3550 7,900		
0 m 0'	11.5 m 38'			*23200 *51,200	16300 35,950	*16650 *36,800	10450 23,100	12800 28,200	7400 16,300	9500 21,000	5450 12,100	*5550 *12,250	3600 7,950		
-1.5 m -5'	11.1 m 36'	*10900 *24,050	*10900 *24,050	*23900 *52,750	15700 34,700	*17250 *38,100	10050 22,150	12500 27,550	7100 15,650	9300 20,550	5300 11,700	*6350 *14,000	3750 8,350		
-3.0 m -10'	10.5 m 34'	*16300 *36,000	*16300 *36,000	*23200 *51,150	15600 34,400	*17050 *37,600	9850 21,700	12300 27,150	6950 15,350	9200 20,350	5200 11,500	7450 16,450	4150 9,200		
-4.6 m -15'	9.5 m 31'	*23100 *50,950	*23100 *50,950	*21250 *46,850	15800 34,800	*15900 *35,100	9900 21,800	*12300 *27,150	6950 15,400	9250 20,450	5250 11,600	*8500 *18,800	4900 10,800		
-6.1 m -20'	8.2 m 27'	*24300 *53,600	*24300 *53,600	*17800 *39,250	16150 35,700	*13500 *29,750	10100 22,350	*10100 *22,300	7150 15,800			*8350 *18,450	6300 13,950		

*Load is limited by hydraulic capacity rather than tipping. Ratings are based on SAE standard No. J1097. Rated loads do not exceed 87% of hydraulic lift capacity or 75% of tipping load.

PC450LC-8 HYDRAULIC EXCAVATOR

LIFTING CAPACITIES



VARIABLE GAUGE LIFTING CAPACITY

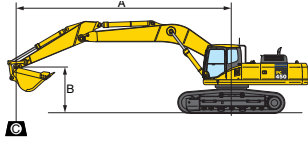

- A: Reach from swing center
- B: Bucket hook height
- C: Lifting capacity
- Cf: Rating over front
- Cs: Rating over side
- ⊗: Rating at maximum reach

Conditions:

- Boom length: 7060 mm 23'2"
- Bucket: 1.90 m³ 2.49 yd³
- Bucket weight: 1325 kg 2,920 lb.
- Lifting mode: On

PC450LC-8		Arm 2400 mm 7'10"		Shoe 900 mm 35.5"												Unit: kg/lb	
B	A	MAX	3.0 m 10'		4.6 m 15'		6.1 m 20'		7.6 m 25'		9.1 m 30'		⊗ MAX				
			Cf	Cs	Cf	Cs	Cf	Cs	Cf	Cs	Cf	Cs	Cf	Cs			
7.6 m 25'	8.0 m 26'									*11000 *24,300	9550 21,000			*8050 *17,700	*8050 *17,700		
6.1 m 20'	8.9 m 29'									*11250 *24,800	9400 20,800			*7850 *17,300	7150 15,700		
4.6 m 15'	9.4 m 31'				*19750 *43,500	*19750 *43,500	*14800 *32,700	12950 28,600	*12100 *26,700	9100 20,000	10450 23,100	6700 14,700	*7900 *17,500	6350 14,000			
3.0 m 10'	9.7 m 32'						*16800 *37,000	12250 27,100	*13050 *28,800	8700 19,200	10250 22,700	6500 14,400	*8250 *18,200	5900 13,100			
1.5 m 5'	9.7 m 32'						*17850 *39,300	11750 25,900	13450 29,700	8400 18,600	10100 22,300	6350 14,000	*8900 *19,700	5800 12,800			
0 m 0'	9.4 m 31'						*17850 *39,400	11450 25,200	13250 29,200	8200 18,100	10000 22,000	6250 13,800	9550 21,000	5950 13,200			
-1.5 m -5'	8.9 m 29'				*19800 *43,700	18050 39,800	*17100 *37,700	11400 25,100	13150 29,000	8150 18,000	10000 22,000	6250 13,800	10350 22,800	6500 14,300			
-3.0 m -10'	8.1 m 27'	*19250 *42,500	*19250 *42,500	*18900 *41,600	18250 40,300	*15250 *33,700	11550 25,400	*11700 *25,800	8250 18,200				*10150 *22,400	7550 16,700			
-4.6 m -15'	6.9 m 23'			*14750 *32,600	*14750 *32,600	*11750 *25,900	*11750 *25,900						*9100 *20,100	*9100 *20,100			
-6.1 m -20'																	

PC450LC-8		Arm 2900 mm 9'6"		Shoe 900 mm 35.5"												Unit: kg/lb	
B	A	MAX	3.0 m 10'		4.6 m 15'		6.1 m 20'		7.6 m 25'		9.1 m 30'		⊗ MAX				
			Cf	Cs	Cf	Cs	Cf	Cs	Cf	Cs	Cf	Cs	Cf	Cs			
7.6 m 25'	8.0 m 26'									*10100 *22,300	9650 21,200			*10100 *22,300	8600 19,000		
6.1 m 20'	8.9 m 29'									*10550 *23,200	9450 20,800			*9950 *22,000	7100 15,600		
4.6 m 15'	9.4 m 31'				*18100 *39,900	*18100 *39,900	*13850 *30,600	13050 28,700	*11450 *25,200	9100 20,000	*10050 *22,200	6650 14,700	9850 21,700	6250 13,800			
3.0 m 10'	9.7 m 32'						*15950 *35,200	12300 27,100	*12500 *27,600	8650 19,100	10200 22,500	6450 14,200	9250 20,300	5800 12,800			
1.5 m 5'	9.7 m 32'						*17350 *38,200	11650 25,700	13350 29,400	8300 18,400	10000 22,000	6250 13,800	9050 20,000	5650 12,400			
0 m 0'	9.5 m 31'						*17650 *38,900	11300 24,900	13100 28,900	8050 17,800	9850 21,700	6100 13,400	9300 20,500	5750 12,700			
-1.5 m -5'	9.0 m 29'				*22400 *49,400	17750 39,200	*17200 *37,900	11150 24,600	12950 28,600	7950 17,500	9800 21,600	6050 13,400	10050 22,100	6200 13,700			
-3.0 m -10'	8.2 m 27'	*22750 *50,100	*22750 *50,100	*20100 *44,300	18000 39,700	*15750 *34,800	11250 24,800	*12250 *27,000	8000 17,700				*10850 *23,900	7200 15,900			
-4.6 m -15'	6.9 m 23'	*19400 *42,700	*19400 *42,700	*16400 *36,100	*16400 *36,100	*12950 *28,600	11550 25,400						*10550 *23,300	9400 20,700			
-6.1 m -20'																	

*Load is limited by hydraulic capacity rather than tipping. Ratings are based on SAE standard No. J1097. Rated loads do not exceed 87% of hydraulic lift capacity or 75% of tipping load.



STANDARD EQUIPMENT

- Additional fuel filter with water separator
- Alternator, 50 Ampere, 24V
- AM/FM Radio
- Automatic air conditioner with defroster
- Auto-decel
- Automatic engine warm-up system
- Batteries, large capacity, 2 x 12V, 140 Ah
- Boom and arm holding valves
- Cab, capable OPG (FOG) with optional bolt-on top guard, damper mounted
- Counterweight, 9500 kg **20,943 lb**
- Dry type air cleaner, double element
- Electric horn
- EMMS monitoring system
- Engine, Komatsu SAA6D125E-5
- Engine overheat prevention system
- Extended work equipment grease intervals
- Fan guard structure
- Foot plates, slip resistant
- Hydraulic filters, high pressure, in-line
- Hydraulic track adjusters (each side)
- KOMTRAX®
- Large 7" TFT LCD monitor panel
- Operator Protective Top Guard (OPG), Level 1
- Pattern change valve
- Power maximizing system
- PPC hydraulic control system
- Radiator & oil cooler with net
- Rearview mirrors (LH & RH)
- Rearview camera (1)
- Revolving frame deck guards
- Revolving frame undercovers
- Seat belt, retractable 76 mm **3"**
- Seat, suspension
- Service valve (1 additional)
- Starting motor, 11 kW
- Suction fan
- Track guiding guard, each side or center section
- Track roller, 8 each side
- Track shoe
–700 mm **28"** triple grouser
- Travel alarm
- Two boom mode settings
- Undercover for track frame center
- Working lights, 2 (boom and RH)
- Working mode selection system



OPTIONAL EQUIPMENT

- (1) Additional rearview camera, RH side
- Air ride suspension seat
- Arms
 - 2400 mm **7'10"** arm assembly
 - 2900 mm **9'6"** arm assembly
 - 3380 mm **11'1"** arm assembly
 - 3380 mm **11'1"** w/one actuator piping
 - 4000 mm **13'1"** arm assembly
 - 4800 mm **15'9"** arm assembly
- Boom
 - 7060 mm **23'2"** HD boom assembly
 - 7060 mm **23'2"** HD w/one actuator piping
- Rain visor
- Sun visor
- Converter, 12V
- Counterweight removal device
- OPG top guard, Level 2, bolt-on
- Full front guard Level 1
- Full front guard Level 2
- Hydraulic control unit
- Revolving frame undercovers, heavy-duty
- Shoes, triple grouser: 800 mm **31.5"**
- Shoes, triple grouser: 900 mm **35.5"**
- Straight travel pedal
- Track roller guards (full length)
- Variable gauge track frame
- Working light, additional front



ATTACHMENT OPTIONS

- JRB attachments
 - Couplers
 - Smart-Loc
 - Versa-Loc
 - Vandal protection guards with storage box
- Komatsu buckets
- Lincoln autolube systems
- PSM thumbs
- Rockland thumbs

For a complete list of available attachments, please contact your local Komatsu distributor.

AESS803-01

©2010 Komatsu America Corp.

Printed in USA

D04(3M)OSP

04/10 (EV-1)

KOMATSU®